

PPG Semco® Packaging & Application Systems

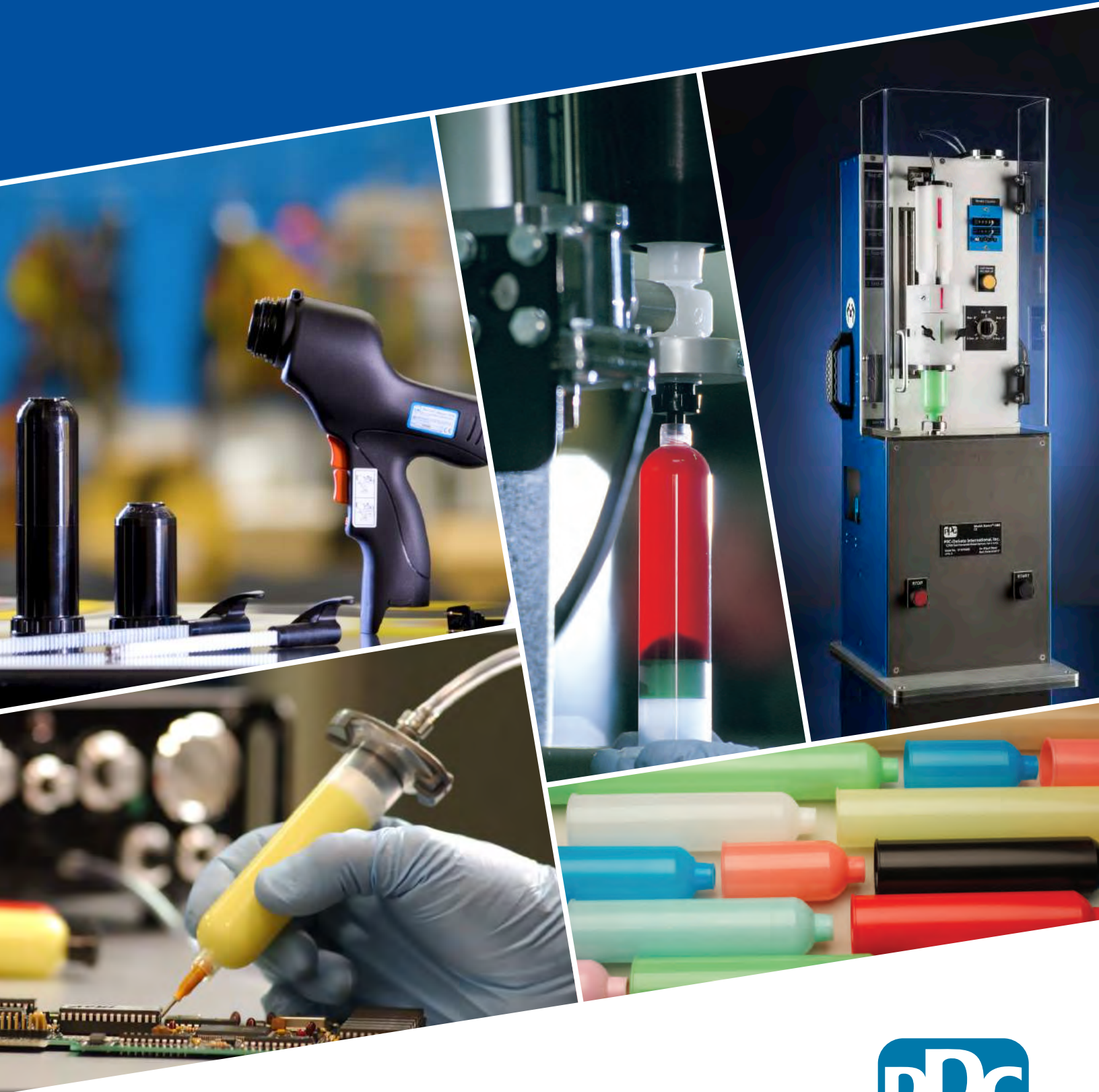



We protect and
beautify the world™

At PPG, we work every day to develop and deliver the paints, coatings and materials that our customers have trusted for 135 years.

Through dedication and creativity, we solve our customers' biggest challenges, collaborating closely to find the right path forward.

With headquarters in Pittsburgh, we operate and innovate in more than 70 countries.

We serve customers in construction, consumer products, industrial and transportation markets and aftermarkets.

We are a leader in all our markets: construction, consumer products, industrial and transportation markets and aftermarkets.



Packaging & Application Systems

Application support centers (ASCs)

We have over 50 years of experience in handling the packaging and dispensing of a variety of materials. Our superior products are available through a global network of PPG application support centers. These facilities are strategically located to provide customers with local service and product support. In addition, each ASC location aims to stock material based on their customers' needs, so that we can deliver our products to your assembly line quickly, safely, and cost-effectively.

Putting our expertise to the test

Our application support center network was specifically created to provide our customers with the benefit of our knowledge and experience. Let our packaging experts put these skills to work for your company. They can help find ways to improve your manufacturing process using our products and services.

We also offer a wide range of chemical packaging services (CPS) through our facilities. In our CPS business, we utilize PPG's trained personnel and aerospace quality standards to repackage third-party sealants, adhesives and other chemicals, both as a toll packager and for each end customer. The right-size materials are then redistributed to your assembly line as application ready packages. CPS is currently available for these products:

- *Semkit* packages
- Syringes
- Hinge packs
- *Semco* cartridges
- Side by side cartridges (for mix on demand applications)
- Many more

Special handling instructions

Our facilities are also capable of managing a wide range of special handling instructions such as hazardous or flammable materials, foil bagging, nitrogen purging, air-free filling, and other services. Our personnel have hands on experience with the most rigorous packaging requirements.



Table of Contents

Semco® cartridges & accessories	4-5
Semkit® package	6-7
Sempen® applicator	8
Semco® nozzles	9-12
Semco® glow-in-the-dark (GID) tools	13
Semco® sealant removal tools	14
Semco® smoothing tools	15
Dispensing guns & accessories	16-25
Semkit® package mixers	26-29
Semco® Model 195 shot meter	30
Time – pressure dispensing	31
Hybrid syringe systems	32-34
Sem-luer / sem-flex needles	35
UV blocking cartridges and syringes	36
Semco® SX cartridge	37
Electronic specialty products	38-39
Side by side dispensing products	40-41
Packaging solutions	42

Cartridges

Disposable plastic cartridges are available in 1, 2.5, 6, 8, 12, 20, 32 fluid oz. and 1/10 gallon capacities. Available in low or high-density natural polyethylene, all sizes are fit with 1/4" NPT female thread dispensing orifice. Special colors are available, however minimum order, lead time, and pricing considerations apply.

The cartridges are capable of handling a wide variety of chemical fluids for storage and application and can be easily adapted to both pneumatic and manual dispensing systems. PPG SEMCO® cartridges are commonly used in single components, plural components or pre-mixed and frozen applications with polysulfides, solder pastes, adhesives, epoxies, urethanes, greases, acrylics, etc.

CP and CWP cartridges are the standard Semco cartridge with either a P or WP plunger inserted. This inserted plunger allows for filling from the dispensing end, reducing the potential for air entrapment and improving production rates.



Cartridges with plungers inserted

Description	Part number
CP 2.5 oz. LD	220323
CP 2.5 oz. HD	220324
CP 6 oz. LD	220325
CP 6 oz. HD	220326
CP 8 oz. LD	220327
CP 8 oz. HD	220328
CP 12 oz. LD	220329
CP 12 oz. HD	220330
CWP 1 oz. LD	232375
CWP 2.5 oz. LD	220331
CWP 2.5 oz. HD	220332
CWP 6 oz. LD	220333
CWP 6 oz. HD	220334
CWP 8 oz. LD	220335
CWP 8 oz. HD	220336
CWP 12 oz. LD	220337
CWP 12 oz. HD	220338
CWP 20 oz. HD	230231
CWP 32 oz. SHD white	233710
CWP 1/10 gallon HD	230268

Cartridges only

Description	Part number
1 oz. LD	220307
1 oz. HD	233222
2.5 oz. LD	220315
2.5 oz. HD	220316
6 oz. LD	220317
6 oz. HD	220318
8 oz. LD	220319
8 oz. HD	220320
12 oz. LD	220321
12 oz. HD	220322
20 oz. HD	229734
32 oz. LD	232921
32 oz. HD	232917
32 oz. SHD white	233656
1/10 gallon LD	230285
1/10 gallon HD	229689



Custom colors are also available

Plungers

Precision molded plungers are available in three styles. Each style has its own functional characteristics. All are designed to fit the cartridge contour, assuring complete dispensing and the elimination of waste.

The WP or wiper plunger has the highest amount of interference. This provides the most complete wiping action on the cartridge inside diameter. The P-plunger has medium interference. It provides clean wiping action, inserts easily, and allows evacuation of entrapped air. The PRS or pressure relief plunger has the least interference. It has been specifically designed to be easily inserted and reduce air entrapment during filling and dispensing. This dramatically reduces problems with dripping or stringing during dispensing.



Plungers only

Description	Part number
1 oz. WP-plunger LD	232364
P-plunger LD (black)	220252
WP-plunger LD	220259
WP-plunger HD	220260
PRS-plunger LD	234414
20/32 oz. WP-plunger LD	229221
20/32 oz. WP-plunger HD	232374
1/10 gallon WP-plunger LD	229756

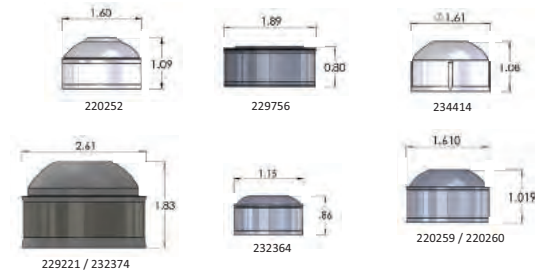

Seals and flange caps

Seals and flange caps are used to ensure retention of the plunger during shipping and storage. The standard color is red. Special colors are available, however minimum order, lead time, and pricing considerations apply.

The flange cap or F-cap is designed to fit over the large open end of the cartridge. There are three seal styles for the dispensing end. The TC-seal is a threaded part that matches perfectly with the dispensing orifice. The TS-seal contacts on three surfaces around and inside the dispensing end of the cartridge. The S-seal fits over the outside of the dispensing orifice only.



Seals and caps

Description	Part number
1 oz. F-cap (red)	232452
F-cap (red)	220238
1/10 gallon F-cap (red)	230502
20 & 32 oz. F-cap (red)	230586
S seal (red)	220257
TS seal (red)	220245
Threaded cap (red)	234411

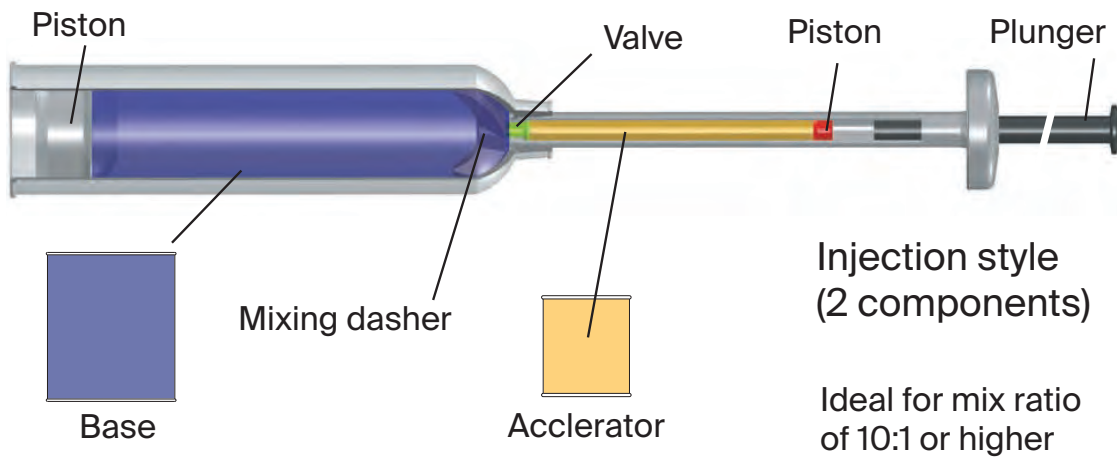
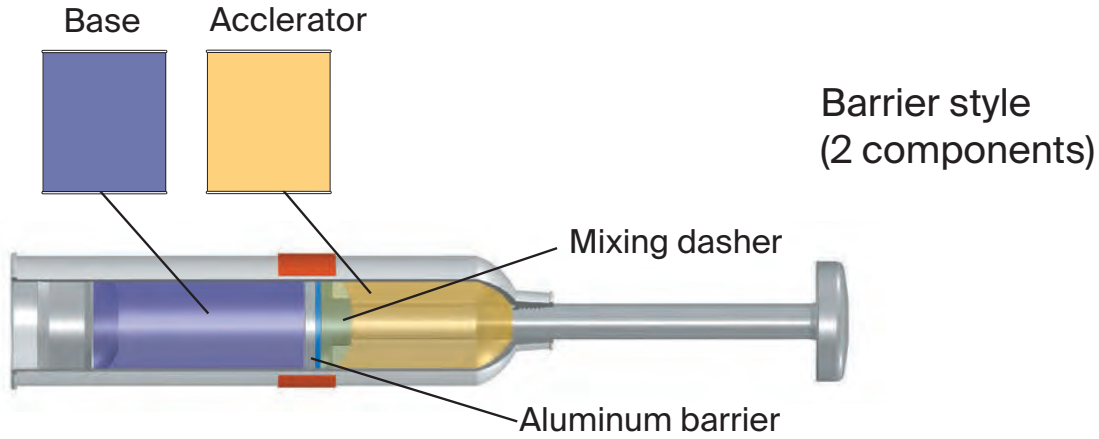

Injection type barrier (3 components)

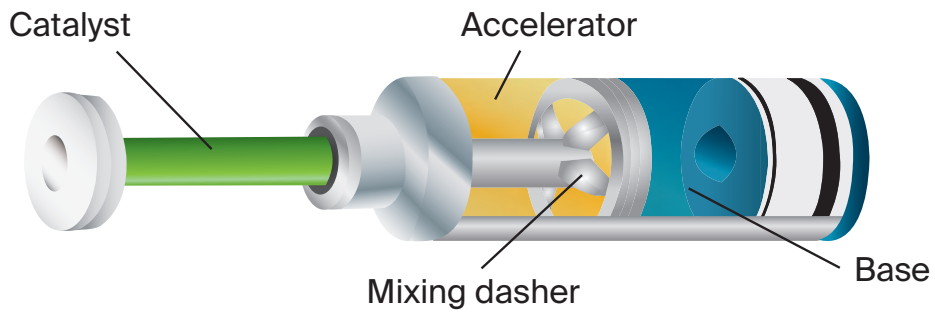

Semkit® package

The PPG SEMKIT® package is a complete, multi-component plastic cartridge assembly which stores, mixes, and applies multiple component adhesives, sealants, encapsulants, and other materials. It has been industry-tested for over 50 years and still represents the best blend of performance and safety available in the industry today. *Semkit* packages are ideal for epoxies, polysulfides, polyurethanes, and silicones used in the aerospace, electronics, automotive, construction, marine, and telecommunications industries. The kit assures material performance, optimum quality, and increased productivity on the production line and in the field.

The *Semkit* package assures accurate proportioning of the materials since the pre-measured components are stored in separate compartments within the cartridge. It eliminates the labor-intensive tasks of measuring and handling materials while minimizing skin contact and material fumes. All the material contained inside the two-component *Semkit* package is mixed within the cartridge and can be extruded with virtually nothing remaining. This configuration provides added value by eliminating material exposure and contamination, dramatically reducing waste, and ensuring the correct ratio of each material is used in every application.

There are two styles of *Semkit* packages: injection and barrier (and a combination of both). Injection kits are typically used with mix ratios of 10:1 or higher. In this kit, the base material is contained in the cartridge, while the catalyst is stored inside the injection rod. Barrier style kits are typically used with mix ratios of 1:1 to 10:1. Both materials are contained in the cartridge and are separated by a foil barrier.

Operators can mix the kit manually, semi-automatically, or automatically. It can then be fitted with a special nozzle and placed in a *Semco* pneumatic or manual dispensing gun. After application, the nozzle and kit are disposable, reducing labor and production costs. The *Semkit* package mixes a wide range of materials with varying viscosities. No special storage is required.



Complete kits, injection style

Description	Part number
1 oz. cartridge with 6" rod	678
2.5 oz. cartridge with 6" rod	655
6 oz. cartridge with 6" rod	654
1 oz. cartridge with 8" rod	678
2.5 oz. cartridge with 8" rod	655
6 oz. cartridge with 8" rod	654
8 oz. cartridge with 8" rod	669
1/10 gallon cartridge with 8" rod	690
20 oz. cartridge with 8" rod	689

Barrier style

Description	Part number
1 oz. cartridge taped	676
1 oz. cartridge untaped	676
2.5 oz. cartridge taped	653
2.5 oz. cartridge untaped	653
6 oz. cartridge taped	651
6 oz. cartridge untaped	651
8 oz. cartridge taped	668
8 oz. cartridge untaped	668
1/10 gallon cartridge taped	691
1/10 gallon cartridge untaped	691
20 oz. cartridge taped	688
20 oz. cartridge untaped	688

Due to the range of our product line, the part numbers shown are base numbers only. Please call or email: semcoinfo@ppg.com for further assistance.

Sempen® applicator

The PPG SEMPEN® applicator is designed for the convenient storage, mixing, and application of pre-measured, multicomponent coating materials and assembly fluids in touch up quantities. The pen assembly is supplied with two precisely metered materials that are barrier separated during storage. This system is ideal for low viscosity primers and topcoats used in the aerospace, electronics, automotive, and marine industries. The pen assures material performance, optimum quality, and increased productivity on the production line and in the field.

The *Sempen* applicator provides superior coverage and material performance. Its fail-safe metering system holds a maximum of 10 ml and allows exact amounts of the material to be accurately mixed and applied to a film thickness up to 2 mils. Prior to use, the barrier disc is displaced to allow thorough mixing of the materials. After the materials have been mixed, the user can apply variable amounts of coating material to the work surface.

The *Sempen* applicator works efficiently. It allows the user to apply the smallest amounts of material without the need for large containers or equipment, eliminating the risk of material contamination. It offers tremendous cost savings and no special training is required. Everything the user needs to accurately mix and apply two materials is contained in one package that conveniently fits in the user's hand.

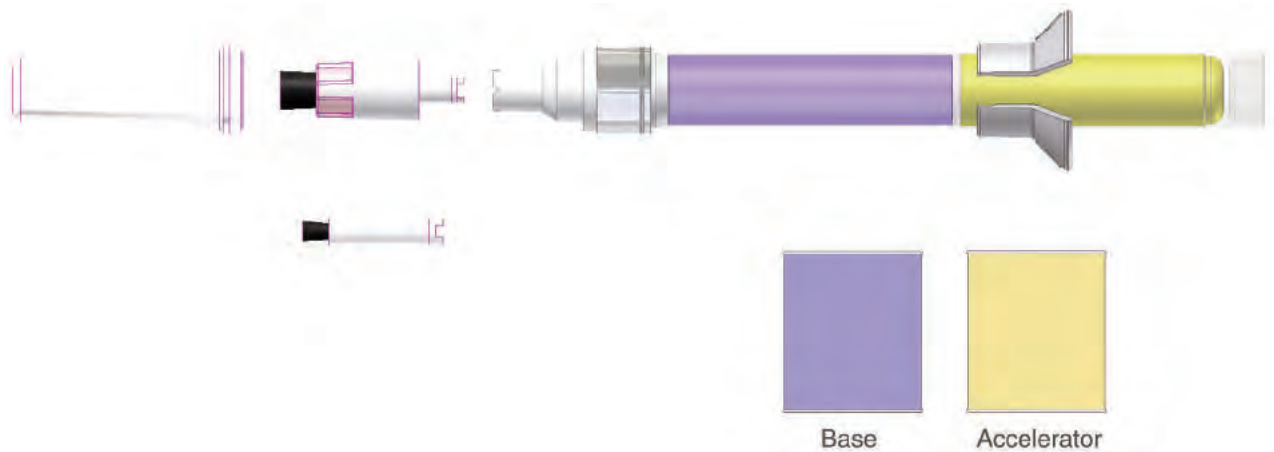

Semco® standard nozzles

These disposable nozzles are precision molded and have a 1/4" NPT male thread to fit Semco 1, 2.5, 6, 8, 12, 20, 32 oz., and 1/10 gallon disposable cartridges. A wide range of lengths and orifice sizes are available to better meet your application needs. Nozzles can be bent to varying degrees, however minimum order, lead time, and pricing considerations apply.

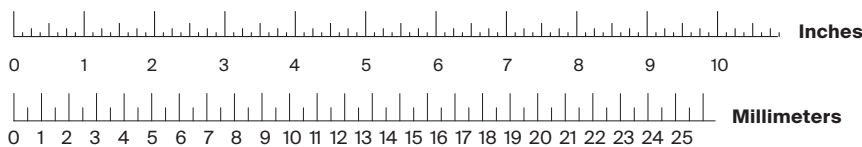
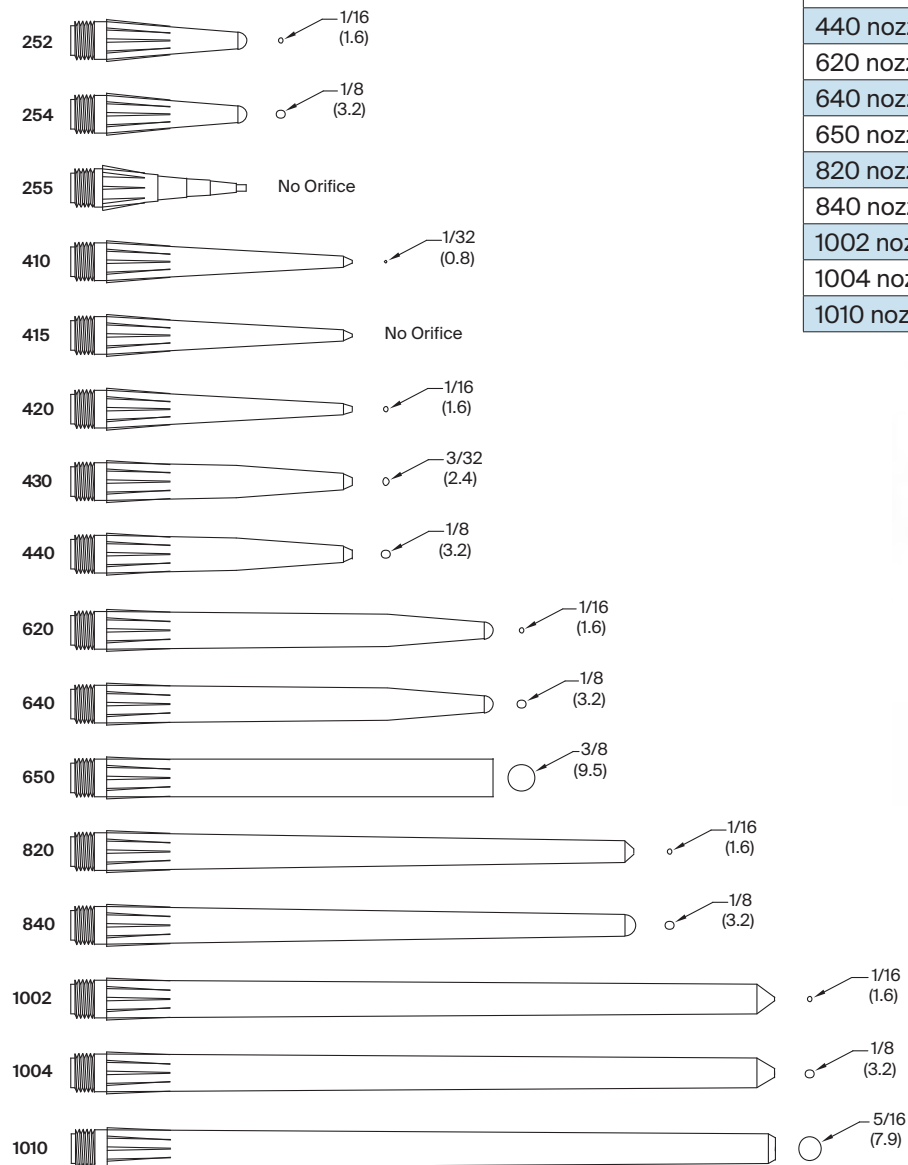

Nozzles

Description	Part number
252 nozzle	220538
254 nozzle	220540
255 nozzle	233495
410 nozzle	220542
415 nozzle	227613
420 nozzle	220544
430 nozzle	220548
440 nozzle	220550
620 nozzle	220553
640 nozzle	220555
650 nozzle	224494
820 nozzle	220557
840 nozzle	220559
1002 nozzle	220561
1004 nozzle	220563
1010 nozzle	220565

Bent nozzles

When ordering bent nozzles, first give the standard number, then the angle of bend (D), then the length of bend from the tip (C).
For example: # 640, 30°, 2"

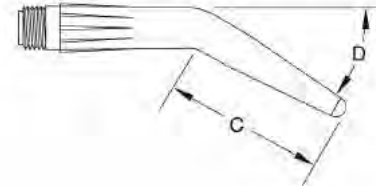

Semco® fillet nozzles

PPG *Semco* fillet nozzles consistently apply sealant fillets over lap joints. These nozzles eliminate the need for tooling the sealant with spatulas, thereby increasing productivity.

The model 425, 426, 427, and 428 nozzles have a built-in step to guide the nozzle along the lap joint. This produces a smooth, uniform fillet. The model 429 nozzle has no step, offering versatility when used at odd angles and in confined spaces.

These disposable nozzles are precision molded and have a 1/4" NPT male thread to fit *Semco* 1, 2.5, 6, 8, 12, 20, 32 oz. and 1/10 gallon disposable cartridges. When these nozzles are used in conjunction with a *Semco* sealant gun, a smooth, uniform fillet can be applied each time.

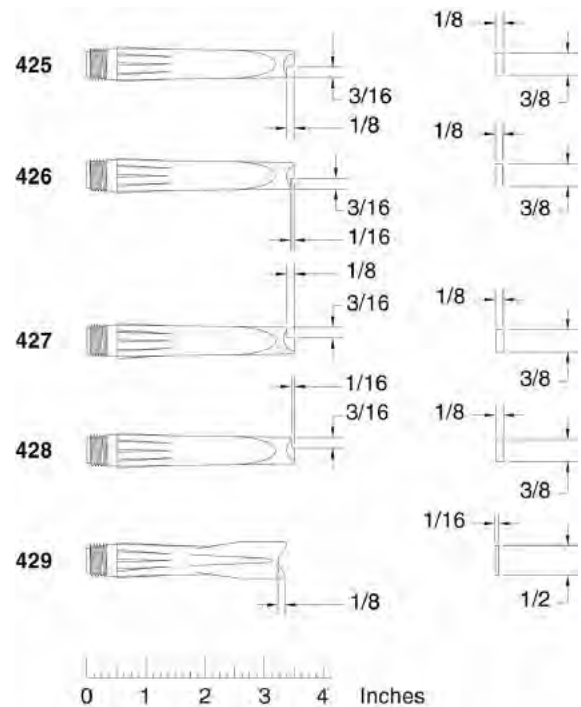

Fillet nozzles

Description	Part number
425 nozzle	232499
426 nozzle	232500
427 nozzle	232501
428 nozzle	232502
429 nozzle	232590

Semco® ribbon and speciality nozzles

These disposable nozzles are precision molded and have a 1/4" NPT male thread to fit *Semco* 1, 2.5, 6, 8, 12, 20, 32 oz., and 1/10 gallon disposable cartridges. A wide variety of specialty ribbon nozzles are available in various thicknesses and widths and are designed to better meet your application needs.

Ribbon and speciality nozzles

Description	Part number
8613 nozzle	220572
8615 nozzle	220574
8630 nozzle	220581
8643 nozzle	220586
8645 nozzle	220587
8646 nozzle	220588
8648 nozzle	220589
Funnel nozzle 1"	231781
Funnel nozzle 2"	231348
Semstraw nozzle	235321

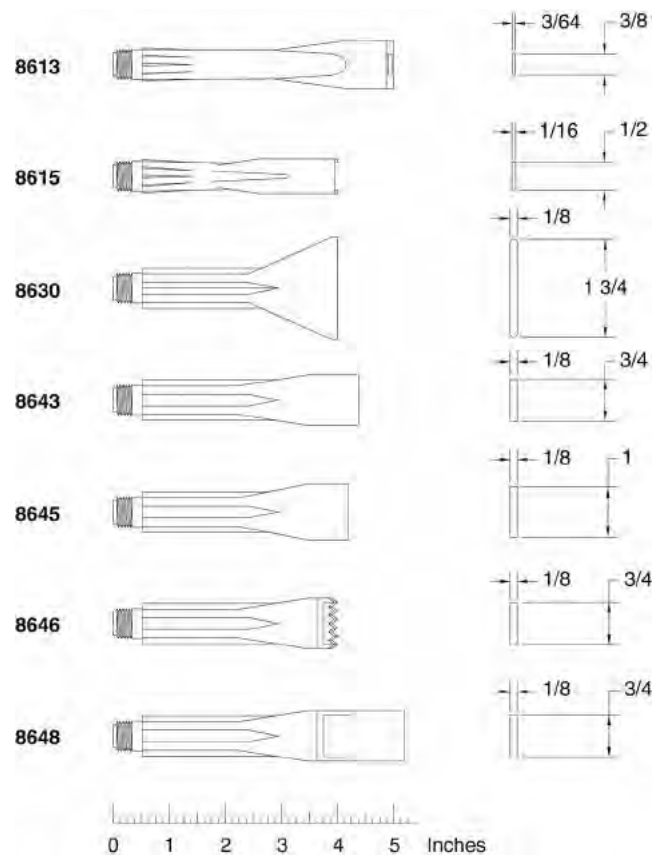

Semco® roller nozzles

PPG *Semco* roller nozzles are designed to apply adhesives and sealants evenly over a wide area of substrate. They are ideal for the application of faying surface sealants. The 1/4" NPT male threaded end can be used with any of the *Semco* disposable cartridges and *Semkit* packages (i.e. 1, 2.5, 6, 8, 12, 20, 32 oz. and 1/10 gallon sizes). Roller nozzles are available in one and two inch widths. The roller base is precision molded of chemically resistant material and can be solvent cleaned for re-use. Replacement rollers can be purchased separately.



Roller nozzles

Description	Part number
1" roller nozzle assembly	232693
2" roller nozzle assembly	232692
1" replacement roller	232701
2" replacement roller	232702

Semco® adapters

These disposable adapters are precision molded and have a 1/4" NPT male thread to fit *Semco* 1, 2.5, 6, 8, 12, 20, 32 oz., and 1/10 gallon disposable cartridges. The syringe filler adapter is designed to allow easy filling of luer lock or luer slip syringes. The sem-luer adapter converts the 1/4" NPT female thread of the standard *Semco* cartridge to a male luer lock connection, allowing the easy attachment of any luer lock needle.

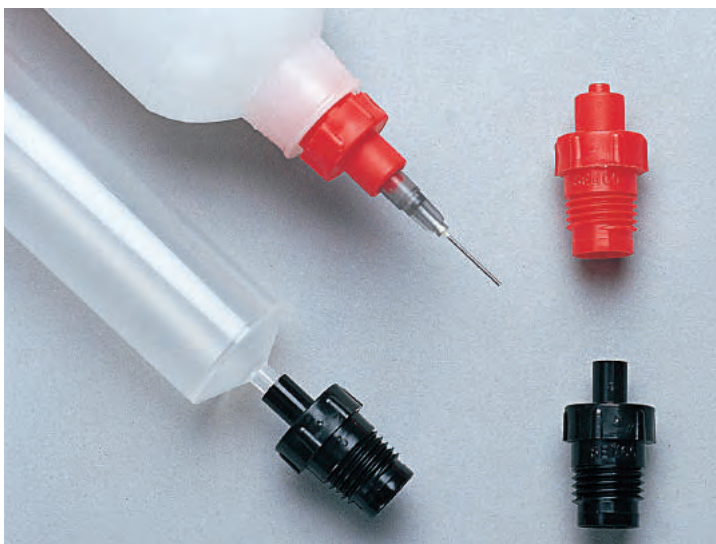

Adapters

Description	Part number
Syringe filler adapter	310025
Sem-luer adapter	231871

Sembend® nozzles

PPG SEMBEND® nozzles have the ability to be reshaped at room temperature without the application of heat or tools. *Sembend* nozzles are available in most of our standard nozzle geometries but some limitations may apply to smaller nozzle configurations. *Sembend* nozzles simply require an operator to slowly bend the nozzle with their hands to form the shape desired for the application. *Sembend* nozzles have excellent shape retention and the capability to continue to be reshaped if the initial forming needs to be adjusted.



Features

- Custom nozzle shapes suitable to each operator’s own preference
- Reduce health and safety concerns during the bending process
- Reduced lead time for pre-bent nozzles (on standard *Sembend* nozzle configurations)
- Increased flexibility for the end-customer relative to pre-bent nozzles which limit them to standard angle bends.

Fillet nozzles

Description	Part number
<i>Sembend</i> model # 420	235065
<i>Sembend</i> model # 620	235061
<i>Sembend</i> model # 640	235062
<i>Sembend</i> model # 820	235063
<i>Sembend</i> model # 840	235064
<i>Sembend</i> model # 8690	235058

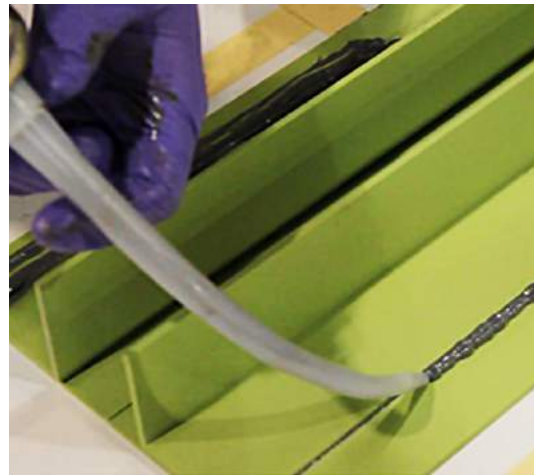

Semco® glow-in-the-dark (GID) tools

Semco glow-in-the-dark (GID) tools are precision molded application tools for sealants, adhesives, and other paste materials commonly used in the aerospace industry. Semco GID tools are designed for use, primarily in areas where limited light is available, such as aircraft fuel tanks (center & wing) or vertical & horizontal stabilizers. Semco GID technology aids operators in finding tools that are dropped or left behind in enclosed areas ultimately minimizing instances of foreign object debris (FOD).

PPG manufactures Semco GID application tools in the following shapes and sizes, offering end users an added benefit to reduce FOD

- Spatulas
- Nozzles
- Scrapers
- Sealant pick

Glow-in-the-dark (GID) tools

Description	Part number
GID orange 10" spatula	235037
GID green 10" spatula	234989
GID green scraper	235028
Sembend orange model 8690	235043
GID orange sealant pick	235038
Sembend orange model 640	235019



Minimum order quantity required for nozzles

Version uploaded 12/11/2019

Semco® sealant removal tools

Our new *Semco* sealant removal tools are ergonomically designed scrapers that improve efficiency of aerospace sealant removal and reduce operator fatigue. The tools are compliant with the primary process specifications used by the aerospace industry, globally. The 11 scrapers have been designed for use by hand for standard sealant removal as well as more difficult and specialty applications such as removal of sealant around fasteners, fillet seals and other hard-to-reach areas. Five tools are made of glass-filled nylon materials for more difficult operations, while six tools designed for standard sealant removal by hand are made of CELCON® acetal copolymer (POM).



Features

- Tools can be sharpened for continued use
- Improve sealant removal rates and reduce operator fatigue
- All *Semco* sealant removal tools are resistant to most solvents and sealant strippers
- *Semco* sealant removal tools made from glass-filled nylon can withstand considerable heat, although not from direct flame or a heat gun

Sealant removal tools

Aircraft program	Process specification	Sealant removal process type	Part number of recommended tool
Boeing Commercial (737 - 787)	BAC 5000 Section 5.2.6.A	Qualified or allowed to be used on unpainted aluminum clad exterior fuselage	234350 235072, 235073, 235074, 235075
Boeing Commercial (737 - 787)	BAC 5000 Section 5.2.6.B	Compliant for all other sealant removal processes not referenced above	234350, 235072, 235073, 235074, 235074, 235075, 235076, 235077, 235078, 235079, 235080, 235081, 235084
Boeing Commercial (737 - 787)	BAC 5504	Compliant for all other sealant removal processes not referenced above	234350, 235072, 235073, 235074, 235075, 235076, 235077, 235078, 235079, 235080, 235081, 235084
Airbus (Commerical & Military)	AIPI 005-005-002-ISS-A2	Compliant for all other sealant removal processes	
Bombardier (Commercial, General Aviation & Regional Jet)	BAPS 157-028	Compliant for all other sealant removal processes	
Various, managed by SAE (General Aviation, Military, Regional Jet, Commercial, etc.)	AIR 4069	Compliant for all other sealant removal processes	

Semco® sealant smoothing tools

These special reinforced plastic spatulas and spreaders are for tooling and smoothing sealants and adhesives.



Sealant smoothing tools

Description	Part number
Spatula	231349
Spatula	226241
Spatula	226242
Spatula	226243
Scraper	234350
Sealant spreader	229394
Comb spreader	229395
Spatula kit (226241, 226242, 226243)	226244

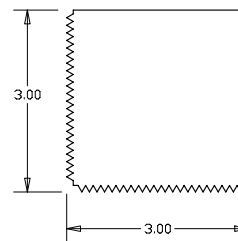
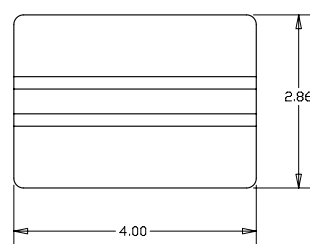
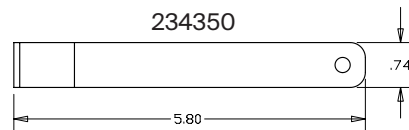
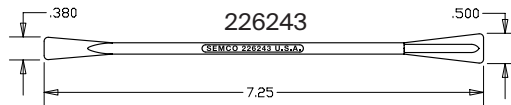
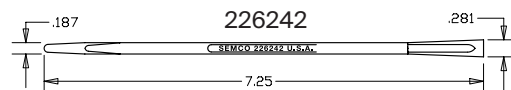
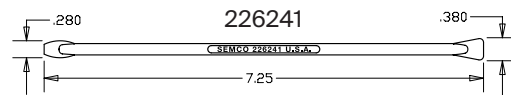
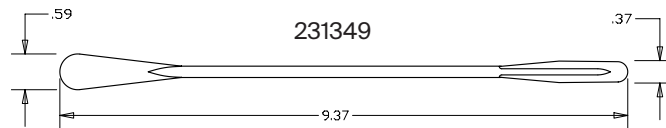

229394

229395

All dimensions are in inches.

Semco® model 250-A sealant gun

PPG Semco model 250-A sealant gun is the standard of the aerospace and electronics industries. It is designed for the quiet, pneumatic application of sealants, adhesives, potting compounds, and other materials packaged in Semco disposable cartridges or Semkit packages for multi-component materials.

The Semco model 250-A gun is available with retainers to fit standard 1, 2.5, 6, 8, and 12 ounce disposable cartridges. Air hoses to operate the gun must be ordered separately (see page 24 for more information).

The gun is constructed of durable metal and engineered plastic parts designed to withstand the rigors of the production work place. The nickel plated retainers are affixed to the valve assembly via a quick connect, secure bayonet lock fixture, permitting easy replacement of cartridges. For use in confined locations, the handle can be easily removed to allow more clearance and better manipulation.



Features

- Reduces applied material cost
- Provides accurate material control
- Lightweight
- Handle can be removed to facilitate application in confined areas
- 0-100 psi (0-6.9 bar) operating range
- Available in 1, 2.5, 6, 8, and 12 oz. sizes
- Bayonet lock on retainer permits quick cartridge change
- Durable, shock resistant parts
- Touch control on trigger regulates flow
- Positive control for smooth, even dispensing
- Ergonomic design
- Quiet operation

Model 250-A gun (with handle)

Description	Part number
1 oz.	250015
2.5 oz.	250255
6 oz.	250065
8 oz.	250085
12 oz.	250125
Gun without retainer	250000

Semco® model 250-B sealant gun

PPG *Semco* model 250-B handleless sealant gun is the new standard of the aerospace and electronics industries.

It is designed for the quiet, pneumatic application of sealants, adhesives, potting compounds, and other materials packaged in *Semco* disposable cartridges or *Semkit* packages for multi-component materials.

The *Semco* model 250-B gun is available with retainers to fit standard 1, 2.5, 6, 8, and 12 oz. disposable cartridges. Air hoses to operate the gun must be ordered separately (see page 24 for more information). The *Semco* gun handle cannot be attached to this model gun.

The gun is constructed of durable metal and engineered plastic parts designed to withstand the rigors of the production work place. The nickel plated retainers are affixed to the valve assembly via a quick connect, secure bayonet lock fixture permitting easy cartridge replacement.



Features

- Reduces applied material cost
- Provides accurate material control
- Lightweight
- 0-100 psi (0-6.9) bar operating range
- Available in 1, 2.5, 6, 8, and 12 oz. sizes
- Bayonet lock on retainer permits quick cartridge change
- Durable, shock resistant parts
- Touch control on trigger regulates flow
- Positive control for smooth, even dispensing
- Ergonomic design
- Quiet operation

Model 250-B gun

Description	Part number
1 oz.	250010B
2.5 oz.	250250B
6 oz.	250060B
8 oz.	250080B
12 oz.	250120B

Semco® model Sealant 350 sealant gun

PPG *Semco* model 350 sealant gun is designed for quiet pneumatic application of sealants, adhesives, potting compounds and other materials packaged in *Semco* disposable cartridges or *Semkit* packages that are used for multi-component materials.

The *Semco* model 350 gun is available with retainers to fit standard 2.5, 6, 8 and 12 oz. (59, 156, 214 and 310 cc) disposable cartridges. Air hoses to operate the gun must be ordered separately.

The gun is constructed of durable metal and engineered plastic parts designed to withstand the rigors of the production workplace. The nickel plated retainers are affixed to the gun via a quick connect, secure bayonet lock feature permitting easy cartridge replacement. A regulating wheel on the handle is used to set the working pressure at the feed volume required.

Features

- Reduces applied material cost
- Provides accurate material control
- Lightweight
- 0-100 psi (0-6.9 bar) operating range
- Available in 2.5, 6, 8 and 12 oz. (59, 156, 214 and 310 cc) sizes
- Bayonet lock on retainer permits quick cartridge change
- Durable, shock resistant parts
- Regulating wheel adjusts the material flow
- Positive control for smooth even dispensing
- Ergonomic design
- Quiet operation



Model 350 gun

Description	Part number
No retainer	350010
2.5 oz. (59 cc)	350255
6 oz. (156 cc)	350065
8 oz. (214 cc)	350085
12 oz. (310 cc)	350125

250-A, 250-B, 350 and 950 retainers

All *Semco* retainers are 100 psi pressure rated and are designed for use with *Semco* guns, cartridges, and dispensing systems. Please contact our technical service department for more information.



250-A, 250-B, 350 and 950 retainers

Description	Part number
1 oz. (only for 250A/250B)	231611
2.5 oz.	220256
6 oz.	220928
8 oz.	220926
12 oz.	220923

Note: 1 oz. does not fit model 350

Semco® model 550 sealant gun

PPG Semco model 550 sealant gun is designed for the pneumatic application of sealant, caulking, adhesive, and other compounds packaged in Semco 1/10 gallon, 20, and 32 oz. cartridges. Parts are available to convert the gun from one size to another. Air hoses to operate the gun must be ordered separately (see page 24 for more information).

These lightweight guns are constructed of cast aluminum and other durable materials. The 1/10 gallon cartridge retainer is secured to the gun via a spring-loaded quick-disconnect using the bayonet locking feature on the retainer. The 20 and 32 oz. retainers can be quickly and easily attached to the gun using a threaded bezel.



Model 550 gun

Description	Part number
1/10 gallon	231551
20 oz.	231218
32 oz.	233688

Features

- Reduces applied material cost
- Provides accurate material control
- Lightweight
- 0-100 psi (0-6.9 bar) operating range
- Available in 20, 32 oz. and 1/10 gallon sizes
- Durable, shock resistant parts
- Touch control on trigger regulates flow
- Positive control for smooth, even dispensing
- Quiet operation

550 retainers

All Semco retainers are 100 psi pressure rated and designed for use with Semco guns, cartridges, and dispensing systems. Retainers for the 20 and 32 oz. guns must be used with the appropriate bezel. Please contact our technical service department for more information.



550 retainers

Description	Part number
20 oz. assembly Includes bezel and retainer	229752
32 oz. assembly Includes bezel and retainer	233695
1/10 gallon	231903

Semco® model 850 manual dispensing gun

PPG *Semco* model 850 gun is a hand-operated, high quality dispensing gun designed to accept *Semco* disposable cartridges or *Semkit* packages.

It is excellent for the “in-field” application of sealants, adhesives, and other materials. The ratchet handle is made of metal for tough, durable, long-term use. A threaded retainer provides a tight fit into the ratchet handle, permitting uninterrupted operation. It also allows for the quick and easy replacement of cartridges. Custom size retainers accommodate *Semco* 1, 2.5, 6, 8, 12, 20, 32 oz., and 1/10 gallon disposable cartridges. The retainers are available in metal or plastic.



Model 850 manual gun

Description	Part Number
1 oz. plastic	231556
2.5 oz. plastic	221825
2.5 oz. metal	221824
6 oz. plastic	221828
6 oz. metal	221830
8 oz. plastic	221832
8 oz. metal	221836
1/10 gallon plastic	230273
20 oz. metal	230274
32 oz. metal	234054

Features

- Portable
- Requires no air or power supply
- Available in 1, 2.5, 6, 8, 12, 20, 32 oz. and 1/10 gallon sizes
- Lightweight
- Rugged, heavy gauge metal construction
- Easy to operate
- Dispenses a wide range of sealants, adhesives, or other materials
- Handles thick, viscous materials

850 retainers

Description	Part number
2.5 oz.	226819
6 oz.	226820
8 oz.	226821
12 oz.	226822
20 oz.	229740
32 oz.	233620
Bezel for 20 oz.	230209
Bezel for 32 oz.	234053
1/10 gallon	229777

850 retainers

All *Semco* retainers are designed for use with *Semco* guns, cartridges, and dispensing systems. A bezel is required to attach 20 and 32 oz. cartridges to the *Semco* model 850 gun series. Please contact our technical service department for more information.



Semco® model 950 gun

PPG *Semco* model 950 sealant gun is a hand operated, very high quality dispensing gun designed to accept *Semco* disposable cartridges and *Semkit* packages. This gun is excellent for the application of sealants, adhesives and other materials in remote areas where no air supply is available, this includes field repair applications.

The smooth stroking ergonomic handle is made of an engineered plastic for tough, durable, long term use. The dispense rod is released from pressure after every stroke to help eliminate material drooling. The bayonet locking retainer provides a tight fit into the handle permitting uninterrupted operation and allows for quick and easy replacement of cartridges.

Custom size retainers accommodate *Semco* 2.5, 6, 8 and 12 oz. (59, 156, 214 and 310 cc) disposable cartridges. The nickel plated retainers are high quality to withstand the demanding environment of an industrial workplace.



Features

- Portable
- Requires no air or power supply
- Available in 2.5, 6, 8 and 12 oz. (59, 156, 214 and 310 cc) sizes
- Ergonomic and lightweight
- Rugged, engineered plastic and metal construction
- Easy and simple to operate
- Dispenses a wide range of sealants, adhesives or other materials
- Handles thick viscous material and very thin liquids

Model 950 gun

Description	Part number
2.5 oz. (59 cc)	950255
6 oz. (156 cc)	950065
8 oz. (214 cc)	950085
12 oz. (310 cc)	950125

Semco® model 1010 high pressure injection gun

PPG Semco 1010 high-pressure injection gun is designed to inject high-viscosity non-curing sealing compounds in void and channel filling applications that require high pressure through small orifices.

The Semco 1010 high-pressure injection gun has a stroke length of 2.0". The orifice pressure is approximately 21x that of the incoming air. The maximum operating pressure for incoming air is 100 psi, which would equate to a maximum pressure rating of 2,100 psi at the application point of an attached 36" reinforced hose.



Model 1010 high pressure injection gun

Description	Part number
Semco 1010 HPI gun	235285

Features

- Pressure relief mechanism prevents accidental channel blowout
- Certified ATEX Group II, Zone 2, and Category 3 for use in areas potentially containing explosive vapors
- CE approved
- Resistance to corrosion in salt-fog testing
- Ergonomic design for easy one-person lift and operation

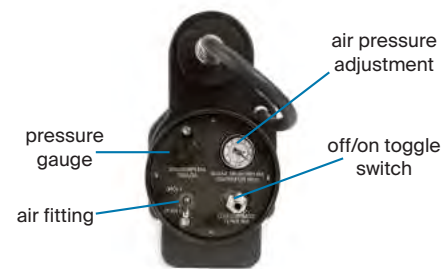
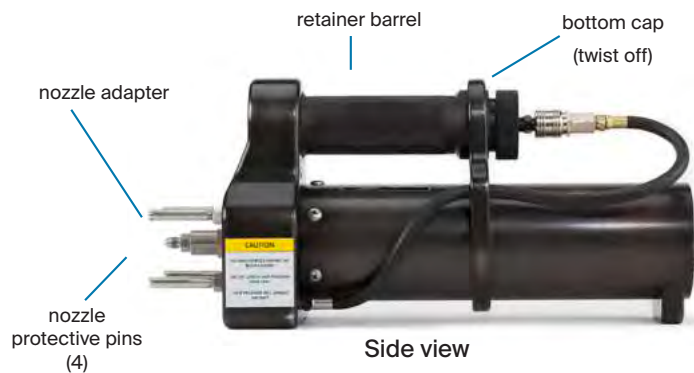

Semco® model 1250 battery powered dispensing gun

PPG *Semco* model 1250 is a battery powered dispensing gun for the application of sealants, adhesives, potting compounds, and other materials packaged in *Semco* cartridges or *Semkit* packages. The unit is designed for use in the aerospace and electronics industries and offers the convenience of a light-weight, powered dispensing solution without an air hose.

Each unit comes with (2) 12 V lithium-ion batteries, a 2.5 oz. threaded plastic retainer, a 6 oz. threaded plastic retainer, a charger base and cord.



Model 1250 battery powered dispensing gun

Part Number	Description
235300	Model #1250 US battery dispensing tool
235301	Model #1250 EU battery dispensing tool
235302	Model #1250 UK battery dispensing tool
235303	Model #1250 AU battery dispensing tool
235311	Battery, spare 12V
235312	Charger w/US cord
235313	Charger w/EU cord
235314	Charger w/UK cord
235315	Charger w/AU cord
229779	2.5 oz. nylon retainer, black
229780	6 oz. nylon retainer, black
235310	Drive rod handle
235309	Drive rod, 6 oz.
235308	Drive rod, 2.5 oz.
235307	Cartridge nut
235306	Retainer mount w/pin
235305	Screw, 10-24
235304	Piston with screw

Features

- Ergonomic design – optimizes the weight balance in operators' hands
- Improved portability, no air hose required
- 60 minutes to completely charge 12 V lithium-ion battery
- Fully charged battery can dispense approximately 50 to 60 six ounce *Semco* cartridges
- Variable dispensing speed control on rear of gun from 1 (low) to 9 (high)
- 2.2 (kN) stall force
- Light weight (less than 3 lb)

Semco® model 120 mini dispensing gun

PPG *Semco* model 120 mini dispensing gun is designed for the precise application of all types of viscous materials including liquids, pastes, etc. It can be used for any assembly, bonding, potting, or sealing application in the electronics, aerospace, and other industrial markets.

The *Semco* model 120 mini dispensing gun's small size and light weight allow for continuous hand service at any ordinary work station or in confined areas at odd angles.



Model 120 mini gun

Description	Part number
Mini 120 with hose assembly	232280

Hose assembly

All hose assemblies come with a B-nut fitting to attach to the *Semco* gun or equipment and the specified quick disconnect attachment. Other lengths and configurations are available. Please contact our technical service department for more information.



Hose assemblies

Description	Part number
Aro hose assembly - 5 ft	280012
Aro hose assembly - 10 ft	280013
Hansen hose assembly - 5 ft	280000
Hansen hose assembly - 10 ft	280001
Schrader hose assembly - 5 ft	280006
Schrader hose assembly - 10 ft	280007
Universal hose assembly - 5 ft (1/4" F-NTP fitting)	231876
Universal hose assembly - 10 ft (1/4" F-NTP fitting)	232649

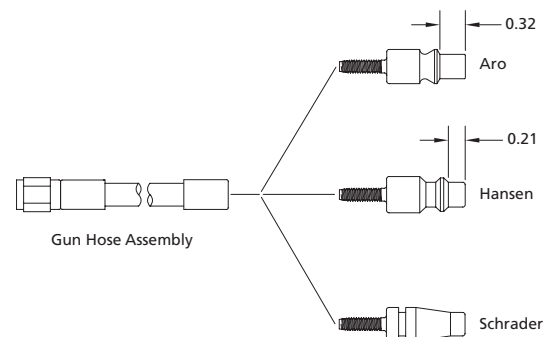

Hands-free dispensing options for all cartridge sizes



550 retainers

Description	Part number
20 oz. assembly Includes bezel and retainer	229752
32 oz. assembly Includes bezel and retainer	233695
1/10 gallon	231903

Repair kits

All repair kits contain the most common components required to repair damage caused by normal wear and tear on our products. Please contact our technical service department for more information.



Repair kits

Description	Part number
Hansen connector assembly	229186
Aro connector assembly	229187
Schrader connector assembly	229188
B-nut assembly	229189
250 A/B gun valve repair kit (shown)	240020

Semco® model 1088 Semkit® package mixer for 2.5, 6 and 8 fluid oz.

PPG Semco 1088 mixer is used for mixing of two-component 2.5 oz., 6 oz., and 8 oz. cartridges with 8 oz. injection and barrier kits with 6" or 8" dasher rods. Semco 1088 mixer can be used with a high degree of flexibility for various products. Its easy operation minimizes operating error. Catalyst can be automatically injected. The automatic stroke adjustment contributes towards consistently high quality mixing results.



Model 1088 Semkit package mixer

Description	Part number
Semco model 1088 auto mixer for Semkit packages	235154

Features

Single switch adjustment to mix common aerospace Semkit package configurations including:

- 2.5 oz with 6" dasher rod
- 2.5 oz with 8" dasher rod
- 6 oz with 6" dasher rod
- 6 oz with 8" dasher rod
- 8 oz with 8" dasher rod
- Guarding to ensure operator safety during mixing
- Stroke counter for improved consistency and quality
- Fully pneumatic non-electrical operation
- Heavy-duty motor to manage very high viscosity materials
- Operates on 85-95 psi, 3 CFM dry air supply
- Shipping weight: 77 lb
- CE approved

Semco® Model 1088-20 CE Semkit® package mixer

The Semco 1088-20 CE mixer is developed for mixing of two-component cartridges of 20 oz. cartridges with an 8" stainless steel dasher rod. Semco 1088-20 mixer can be used with a high degree of flexibility for various products. Its easy operation minimizes any operating errors. The automatic stroke adjustment contributes towards a consistently high quality mixing results.

Model 1088-20 Semkit package mixer

Description	Part number
CE auto mixer for Semkit packages	235197



Semco® model 1188 HD Semkit® package mixer

PPG *Semco* model 1188 HD mixer is equipped with a robust motor to thoroughly mix high viscosity aerospace adhesives and sealants. The *Semco* 1188 HD mixer is ATEX Class II-rated for use in potentially volatile environments. Particularly in aircraft carrier maintenance operations and paint booths. Additionally, it carries specific salt fog resistance for use in some of the world's most corrosive environments.

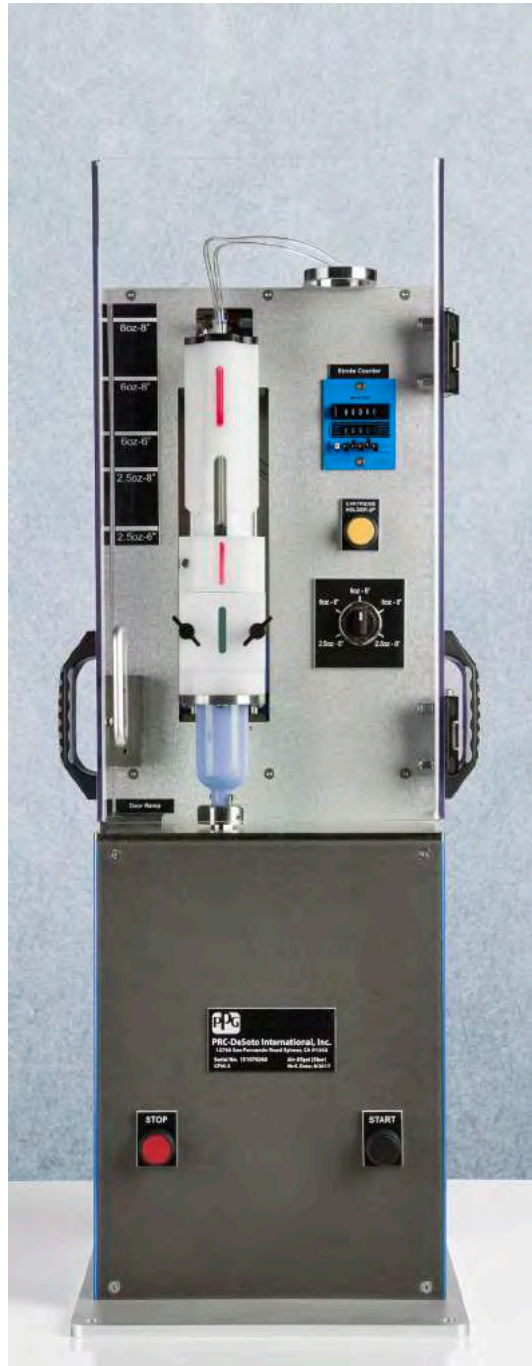

Model 1188 HD Semkit package mixer

Description	Part number
<i>Semco</i> model 1188 auto mixer for <i>Semkit</i> packages	235181

Features

Single switch adjustment to mix common aerospace *Semkit* package configurations including:

- 2.5 oz with 6" dasher rod
- 2.5 oz with 8" dasher rod
- 6 oz with 6" dasher rod
- 6 oz with 8" dasher rod
- 8 oz with 8" dasher rod
- CE approved
- ATEX Class II certified
- MIL-STD-810F method 509.4 - salt fog resistance testing
- Single-switch adjustment for different *Semkit* configurations
- Exclusively pneumatic power
- Operates on 85-95 psi, 3 CFM dry air supply
- Shipping weight: 77 lb

Semco® model 1088 HD Semkit® package mixer

PPG Semco 1088 HD mixer is developed to mix high viscosity material filled cartridges. The two stage motor speed ramp-up along with a customized cartridge holder design allows hands-free automatic mixing for difficult to mix materials. Its high strength construction, reliability, and fully pneumatic control system enable the Semco 1088 HD mixer to have long maintenance intervals and a long service life.

Model 1088 HD Semkit package mixer

Description	Part number
Semco model 1088 HD auto mixer for Semkit packages	235190

Features

- Auto-catalyst injection
- One-touch Semkit package adjustment
- Improved safety and durability features
- Ability to mix very high viscosity chemicals
- Fully pneumatic non-electrical operation
- Heavy duty motor to manage very high viscosity materials
- Operates on 85-95 psi, 3 CFM dry air supply
- Shipping weight: 77 lb
- CE approved



Semco® 488 LW mixer

PPG Semco 488 LW mixer is light weight and specifically designed for customers who want to mix plural component products at dynamic point of use. Examples include ships, aircraft carriers, flight lines or large maintenance bays.

Model 488 LW mixer

Description	Part number
Semco model 488 LW mixer	235260

Features

- Highly portable
- Exclusively pneumatic power
- Configured for 20 oz. cartridges
- Stroke counter – mixer runs based on stroke count, not a timer
- Critical switches moved to flat surfaces to reduce opportunities for damage
- Shipping weight: 40 lb
- Operates on 85-95 psi, 3 CFM dry air supply



Semco® model 388 automatic Semkit® package mixer

PPG Semco model 388 Semkit package mixer provides automatic mixing of filled Semkit packages. Use of the mixer reduces worker fatigue and assures the user a more thorough and consistent mix, kit to kit.



Model 388 automatic Semkit mixer

Description	Part number
Electric/pneumatic 2.5, 6, 8 oz.	221269
Electric/pneumatic 1/10 gallon	230323
Electric/pneumatic 20 oz.	231145
Electric/pneumatic 1 oz.	232410
Fully pneumatic 2.5, 6, 8 oz.	232523

Features

- Automatic mixing of Semkit packages
- Assures consistent, thorough and uniform mixing
- Easy to operate
- Timer automatically shuts mixer off at pre-set mix time
- Eliminates mixing labor and worker fatigue
- Operates on 40-90 psi, 1.2 CFM and 115 VAC
- Shipping weight: 75 lb

Semco® model 285 portable electric Semkit® package mixer

PPG Semco model 285 Semkit package mixer provides semi-automatic mixing of filled Semkit packages. Use of the mixer reduces worker fatigue and assures a more consistent, uniform mix. The drive spindle rotates the mixing rod while the operator strokes the cartridge vertically. This permits the rotating dasher to thoroughly mix the materials. The bell timer alerts the operator when the mix cycle is completed.



Semi-automatic electric mixer

Description	Part number
Semco model 285-A mixer (110 V)	229340
Semco model 285-E mixer (220 V)	234535
Semco model 285P mixer (pneumatic)*	233500

Features

- Semi-automatic mixing of Semkit packages
- Easy to operate
- Provides consistent, uniform mixing
- Reduces time and effort for thorough mixing
- Portable
- Bell timer signals completion of mix
- Operates on 115 VAC
- Shipping weight: 14 lb

*285-E mixer is CE certified, part number for pneumatic version.

Not CE approved (can be sold in Europe).

Version uploaded 12/11/2019

Semco® model 195 shot meter

This positive displacement shot meter allows for precise dispensing of .1 to 20 cc's of material. Ideally suited for syringe filling, this system uses the 2.5, 6, 8, 12, 20, and 32 oz. *Semco* cartridges as material reservoirs.

Please note: Part numbers shown are for the 6 oz. cartridge only. Please contact your local representative for more information.



Model 195 shot meter

Description	Part number
13 cc piston	228953 P0006
20 cc piston	228953 P2006

Features

- Positive displacement
- All parts exposed to material are disposable
- Handles a wide range of viscosities
- Shot size is from 0 to 13 cc, reproducible +/- 0.02 cc
- Foot valve-actuated
- Panel mounted air pressure regulator and gauge included for reservoir
- Dimensions: 31"x 8"x 15" (78.7 cm x 20.3 cm x 38.1 cm)
- Shipping weight: 16 lb



Sematic® series 2200 dispensing unit (SD340*)

PPG SEMMATIC® series 2200 dispensing unit (SD340*) is a precision system that applies accurate, consistent amounts of adhesives, lubricants, silicones, epoxies and other assembly fluids from controlled beads to uniform dots.

The benefits of the system's consistent fluid application include higher yields, reduced material costs, better process control, and a safer working environment. The *Sematic* series 2200 dispensing unit (SD340*) features digital timer control with a range of 0.01 seconds to 31 seconds and vacuum draw back to prevent dripping when dispensing low viscosity fluids. The unit is supplied complete with a *Semco* hybrid syringe "starter pack" of high quality, precision molded *Semco* disposable components. **Please contact your local PPG ASC or email semcoinfo@ppg.com for more information.**



Series 2200

Description	Part number
<i>Sematic</i> 2200 dispensing unit (SD340*)	500000

*SD340 *European version.*
Available only in Europe.



Pneumatic adapter assemblies

Adapter assemblies are designed to attach syringes quickly and easily to pneumatic dispensing equipment. These assemblies allow the attachment of the *Semco* hybrid syringe series to all *Sematic* dispensing units.

Please note: These assemblies will not fit other *Semco* syringes.



Pneumatic adapter heads

Description	Part number
5 cc adapter head assembly	360500
10 cc adapter head assembly	361000
30 cc/55 cc adapter head assembly	363000

Version uploaded 12/11/2019

Patented hybrid technology reduces air entrapment!
This gives our customers a technology, quality and application advantage!

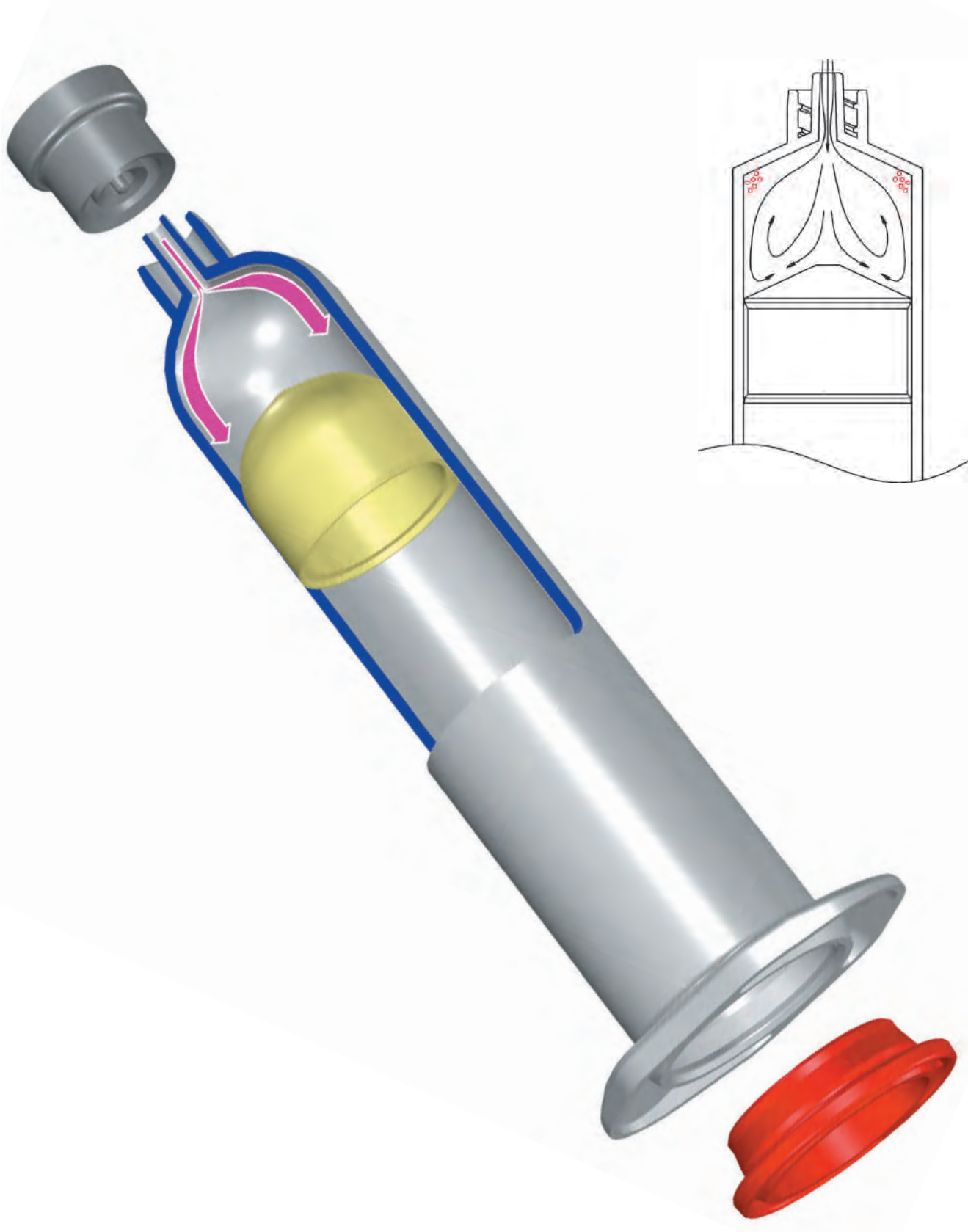

Semco® hybrid syringe barrels

Our patented *Semco*® hybrid syringe barrels dramatically reduce air-entrapment by eliminating the sharp corners found in most traditional syringes. The radius neck reduces voids or pockets of air created during filling. All barrels are molded of polypropylene and are manufactured silicone free. The *Semco* hybrid syringe range is available in natural, black and light blue UV block as standard stock items. Other colors are available but minimum order quantities, lead time, and pricing considerations do apply.

Barrel dimensions

	A	B
5cc	.60"	2.95"
10cc	.75"	3.50"
30cc	1.0"	4.57"
55cc	1.0"	6.90"

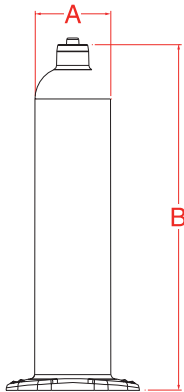

Size	Clear	Opaque black
5cc	360516	360522
10cc	361016	361022
30cc	363016	363022
55cc	365516	365522

Hybrid syringe barrels

Item description	Part number	Material	Typical weight (g)
5 cc syringe barrel, natural	360516	PP	4.1
10 cc syringe barrel, natural	361016	PP	6.9
30 cc syringe barrel, natural	363016	PP	12.7
55 cc syringe barrel, natural	365516	PP	21.1
5 cc syringe barrel, black	360522	PP	4.0
10 cc syringe barrel, black	361022	PP	6.9
30 cc syringe barrel, black	363022	PP	12.7

Semco® hybrid pistons

There are three different pistons to meet your application needs: A micro-interference fitting P-piston, a low friction piston (LF), and a non-interference fitting piston (NI).

The higher the interference, the cleaner the wiping action on the inner diameter of the syringe barrel. However, this increases the potential for air-entrapment. You may want to sample a variety of pistons to find the right product for your material and application. Each piston is molded from polyethylene and meets the rigid requirements of high tech industries.



WP-piston P-piston LF-piston NI-piston HI-piston

Hybrid syringe pistons

Description	Part number
5 cc P-piston, yellow	360505
5 cc WP-piston, red	360504
10 cc P-piston, yellow	361005
10 cc LF-piston, white	361035
10 cc NI-piston, blue	361008
30 cc/55 cc P-piston, yellow	363005
30 cc/55 cc LF-piston, white	363035
30 cc/55 cc NI-piston, blue	363008
10 cc WP-piston red	361004
30 cc WP-piston red	363004
30/55 cc HI-piston green	363009

Semco® flange caps

Flange caps are designed to seal the large open end of the syringe, ensuring the piston is contained and that no contaminants come in contact with material during storage and shipment. All hybrid flange caps have a special tamper evident feature. In order to remove the cap, the user must detach the safety seal, which is then used as a pull ring to remove the cap, clearly identifying if the product has been opened.



Flange caps

Description	Part number
5 cc flange cap	360503
10 cc flange cap	361003
30 cc flange cap	363003



Semco® tip caps

Tip caps are used to seal the syringe dispensing tip during storage and shipment. Three different styles are available to fit any luer lock or luer slip connection. Our patented black spike tip cap has a stem or “spike” that is inserted into the syringe dispensing tip. This helps evacuate air during and after filling. The large flat surface enables the user to store the syringe with the dispensing tip down. This allows any existing air to migrate toward the syringe piston, where it can be easily evacuated. Please contact our technical service department for more information.



Tip caps

Description	Part number
Black spike tip cap	310045
Grey rubber tip cap	232683
Red plastic tip cap	232991
Black no spike tip cap	310060

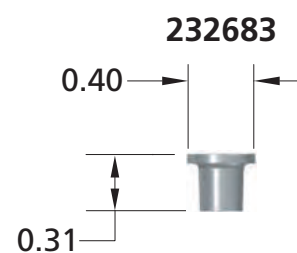
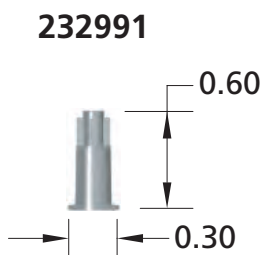
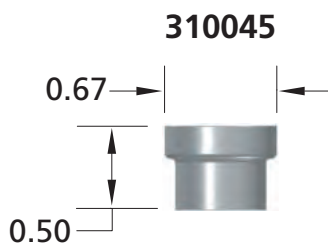

Sem-luer / sem-flex needles

The sem-luer needles are constructed with rigid stainless steel, blunt-end tubing. The sem-flex needles are constructed with flexible Teflon®, blunt-end tubing. Both product lines are designed to fit all luer lock and luer slip connections. All *Semco* needles are manufactured with a plastic, international color coded hub for easy size identification. These products are precision manufactured for micro-dot and bead applications. All needles are non-sterile and intended for industrial use only. The sem-flex needle is specifically designed for use with cyanoacralates or anaerobic materials and will not scratch or blemish sensitive surfaces.



Sem-luer needles

Part #	Gage	O.D.	I.D.	Length	Hub color
231843	14	.083"	.066"	1/2"	Dark green
231844	14	.083"	.066"	1"	Dark green
231845	15	.072"	.060"	1/2"	Orange
231846	15	.072"	.060"	1"	Orange
231849	18	.049"	.038"	1/2"	Pink
231850	18	.049"	.038"	1"	Pink
231851	19	.042"	.032"	1/2"	Brown
231852	19	.042"	.032"	1"	Brown
231853	20	.035"	.026"	1/2"	Yellow
231854	20	.035"	.026"	1"	Yellow
231855	21	.032"	.023"	1/2"	Green
231856	21	.032"	.023"	1"	Green
231857	22	.028"	.020"	1/2"	Black
231858	22	.028"	.020"	1"	Black
231859	23	.025"	.017"	1/2"	Light blue
231860	23	.025"	.017"	1"	Light blue
231863	25	.020"	.012"	1/2"	Blue
231864	25	.020"	.012"	1"	Blue
231866	26	.018"	.010"	1/2"	Peach
231867	27	.016"	.009"	5/16"	Tan
231869	30	.012"	.006"	5/16"	Lavender

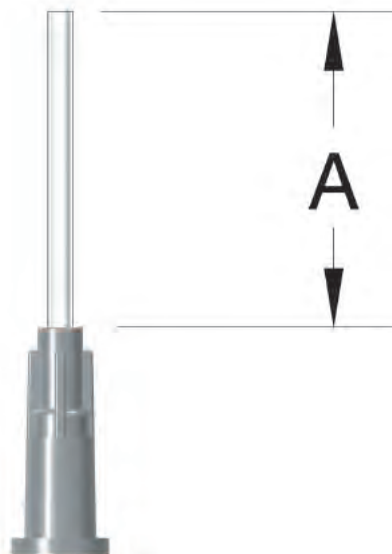

Sem-flex needles

Part #	Gage	O.D.	I.D.	Length	Hub color
232728	14	.082"	.066"	1"	Dark green
232734	18	.054"	.042"	2"	Pink
232736	20	.046"	.034"	1"	Yellow
232748	28	.027"	.015"	1"	Tan
232749	30	.024"	.012"	1/2"	Lavender

The above PN and dimensions are for the USA only . Please contact your local ASC for relevant information on these products.

UV blocking cartridge and syringe technology

PPG *Semco* UV blocking cartridges and syringes are translucent disposable plastic packaging containers intended to store and dispense UV activated fluids. This product line is fabricated from a polypropylene-based raw material that prevents UV light from reaching the container's contents. This unique line of cartridges and syringes is compatible with most existing *Semco* pistons and plungers.



Features

- Blocks UV light, preventing UV-activated materials from reacting
- Non-leaching material reduces likelihood of contamination
- High transparency up to 85 mil wall thickness
- Visible liquid level even for a transparent liquid
- Compatible with existing plungers, piston, and dispensing equipment
- Available in standard cartridge and syringe sizes

UV blocking cartridges and syringes

Description	Part number
30 cc syringe UV amber	363027
55 cc syringe UV amber	365527
30/55 LF piston, black	363036
Wiper piston, black	363012
32 oz. PP UV amber	235005
20/32 wiper plunger, black	234374
Tri-seal cap, black	220244
Threaded cap seal, black	234415
20/32 F-cap, black	234401
20/32 wiper plunger, white	234994
6 oz. cartridge UV amber	235001
2.5 oz. cartridge UV amber	235048

Semco® SX cartridge

Disposable coaxial cartridge and dispensing system

PPG Semco SX cartridge is a disposable coaxial cartridge and dispensing system, which accurately mixes and dispenses a pre-determined ratio of two component materials. Both sections of the cartridge have their own molded pistons. As both pistons are pushed forward by a dual shaft connected to a single-drive cylinder, the two components are pushed together to mix and react through a static mix nozzle. A control valve located at the outlet of the cartridge provides positive on/off flow control before mixing, preventing cross contamination and wasted material. A divider plate keeps components separate until they reach the mixing elements.

Features

- Coaxial design provides a higher dispense rate than most side-by-side cartridges
- Reduces material waste with its no drip valve
- Design offers the best cost/performance ratio with excellent chemical resistance
- Provides large capacity – up to 420 ml (14.2 oz)
- Eliminates hand weighing and mixing – ideal for fast-reacting materials
- Pneumatic dispensing gun is compatible with all Semco SX cartridges
- Low pressure loss during dispensing of high viscosity materials.
- Designed to eliminate ballooning of cartridge sidewalls.

SX cartridge

Part number	Volume ratio	Net volume	Material of construction
456006	1:1	382 ml (12.9 oz.)	PP
456014	4:1	404 ml (13.8 oz.)	HDPE
456021	10:1	420 ml (14.2 oz.)	HDPE



Dispenser ordering information

High-pressure pneumatic dispensers
 PN: 456051..... all mix ratios

Manual gun dispensers

PN: 456056 1:1
 PN: 456057 4:1
 PN: 456058 10:1



Version uploaded 12/11/2019

Semco® solder paste jar

PPG Semco solder paste jar is compatible with standard mixers and viscometer including the Malcom Viscometer, Malcom solder paste aixer, ARE-310 THINKY mixer, and FlackTek DAC 600.1 FVZ mixer.



Features

- Ergonomic quarter turn lid thread design that reduces assembly labor and assures an air tight seal
- Lid that provides tactile feedback to signify the jar has been assembled properly
- Specialized rounded bottom jar design minimizes solder paste waste
- Compatible with industry standard viscometers and mixers
- A variety of specialized color options
- Custom designs (company logos or brand identifiers) for the lid of the jars are available

Semco® solder paste jar

Individual jar part numbers		
Part number	Description	Color
235100	Cup	White
235101	Lid	White
235102	Top seal	Natural
235103	Follower plate	Natural
235104	Cup	Green
235105	Lid	Green
235106	Cup	Teal
235107	Lid	Teal
235108	Cup	Natural
235109	Lid	Natural
235110	Cup	Pink
235111	Lid	Pink

Four piece jar assembly		
Part number	Description	Color
235120	Jar assembly	White
235121	Jar assembly	Green
235122	Jar assembly	Teal
235123	Jar assembly	Natural
235124	Jar assembly	Pink

Four piece jar assemblies include cup, lid, seal and vented follower plate

Three piece jar assembly		
Part number	Description	Color
235125	Jar assembly	White
235126	Jar assembly	Green
235127	Jar assembly	Teal
235128	Jar assembly	Natural
235129	Jar assembly	Pink

Three piece jar assemblies include cup, lid and seal

ProFlow™ cassette

Manufactured under license from DEK/Novatech, PPG has designed and produced the *ProFlow* cassette. This product is specifically designed to be used with DEK manufacturing equipment for screen print solder paste applications. It includes four basic components (cassette base, aluminum foil barrier, piston with seal, and snap-fit cap). The cap comes in black or green to color code your products.



ProFlow cassette

Description	Part Number
Assembly 1 includes: base w/foil attached, piston w/gasket assembled, black cap	234607
Assembly 2 includes: base, foil, piston w/gasket assembled, black cap	234608
Assembly 3 includes: base w/foil attached, piston w/gasket assembled, green cap	234632
Assembly 4 includes: base, foil, piston w/gasket assembled, green cap	234636

“Green” ProFlow™ cassette

To meet the needs of the ever-increasing lead-free solder paste industry, PPG now offers a “green” identifier to minimize confusion with end users. This assembly includes a green foam diamond on the piston and a green cassette lid.



“Green” ProFlow cassette

Description	Part number
<i>ProFlow</i> cassette assembly, “green” Includes: base w/foil attached piston w/gasket assembled, green cap	234632
“Green” foam insert (unassembled)	234635
“Green” <i>ProFlow</i> cap	234631

Dual barrel syringes

Application system for 2-component products available in 2.5 ml, 5 ml, 10 ml, and 25 ml sizes with a choice of mix ratios. A variety of attachable static mixers are available so you can ergonomically manually dispense a wide range of materials.



Static mixers

Mix on demand with many choices of mixing nozzles. With options in length, diameter, and element technology, you can use the mixer that best fits your material and application.



Sempak™ dual barrel cartridges

Application system for 2-component products available in 50 ml and 75 ml sizes with a choice of mix ratios. They keep the two components separate until the material is pushed through the static mixer and are excellent for portable and partial use applications.



Sempak™ large dual barrel cartridges

Application system for 2-component products available in 200 ml and 400 ml sizes with a choice of mix ratios. They keep the two components separate until the material is pushed through the static mixer and are excellent for higher volume mix on demand applications.



Packaging solutions

Using ingenuity and creative thinking, we develop packaging solutions that offer the most benefit to our customers. You may find a solution to your particular needs from the examples here.

ISO9001-approved, PPG Semco Packaging & Application Systems, has been recognized as a leader in chemical packaging for almost 50 years. By producing critical-tolerance injected molded parts, PPG Semco Packaging & Application Systems complement our specialty packaging services with unique technology.



Injection style *Semkit* packages for multi-component adhesives and sealants



Barrier style *Semkit* packages for structural adhesives



Glass bottles for various primers, accelerators and activators



Pre-mixed and frozen touch up kits



Tamper proof screw top jars



Variety of multi-purpose plastic bottles



Metal cans for corrosive materials



Collapsible aluminum tubes

Additional capabilities

Two other value-added services offered by our global network of application support centers are pre-mixing and freezing two-part resin systems and providing specialty resin blending based on customer-designated formulas.

The pre-mixed and frozen process includes thoroughly blending two-component materials, degassing them to remove entrapped air, and then freezing the resin system in a disposable syringe or cartridge. These containers are then packed in dry ice and shipped directly to the customer's facility where they can be stored safely and conveniently in a freezer at -40°C .

For the custom blending process, PPG offers to manufacture your adhesive products based on your specific formulations and specifications. PPG then packages and provides the custom resin in a disposable package best suited for your application requirements.



Pre-mixed and frozen packages



Syringe-filled packages



2-part hinge paks

Packaging & Application Systems

Locations

We have seven North American application support centers: Atlanta, Dallas, Indianapolis, Los Angeles, Philadelphia, Seattle and Canada. Internationally we have facilities in Australia, China, Dubai, Germany, France, Japan, Singapore and the United Kingdom.



For the application support center nearest you, please visit our website at www.semcopackaging.com

All recommendations, statements, and technical data contained herein are based on test we believe to be reliable and correct, but accuracy and completeness of said tests are not guaranteed and are not to be construed as a warranty, either expressed or implied. User shall rely on his own information and tests to determine suitability of the product for the intended use and assumes all risks and liability resulting from his use of the product. Seller's and manufacturer's sole responsibility shall be to replace that portion of the product of this manufacturer which proves to be defective. Neither seller nor manufacturer shall be liable to the buyer or any third person for injury, loss, or damage directly or indirectly resulting from use of, or inability to use, the product. Recommendations or statements other than those contained in a written agreement signed by an officer of the manufacturer shall not be binding upon the manufacturer or seller.

Semco, Semkit, Semmatic and Sempen are trademarks of PRC-DeSoto International, Inc. Teflon is a registered trademark of Proflow and DirEkt Imaging are registered trademarks of DEK Printing Machines Ltd.

Semco Dispensing Products

Proudly distributed by Synergy Devices

PRC-DeSoto International, Inc.
12780 San Fernando Road
Sylmar, California 91342 USA
Telephone (818) 362-6711
Toll Free (800) 237-6649
www.semcopackaging.com
Email: semcoinfo@ppg.com

*SpeedMixer*TM

Mixing Solutions

by **Synergy**Devices

Mixing With Safety

Non-Invasive



No Clean-up



*All mixing in
sealed containers*



Version uploaded 12/11/2019

Unit 2, Network 4,
Lincoln Road, Cressex Business Park
High Wycombe
Buckinghamshire
HP12 3RF, UK
+44 (0) 1494 769020
www.speedmixer.co.uk